

VocoPro

ULTIMATE CHOICE OF KARAOKE ENTERTAINMENT

FEATURES:

- Multi-format disc player supports DVD, DivX®, VCD, CDG, MP3, PHOTO-CD, HDCD and CD/DVD-R RW formats for unparalleled media entertainment compatibility
- Experience the convenience of a jukebox on a disc, enjoying hours of selected audio/video files from custom DivX® discs, each capable of holding hundreds of DVD quality audio/video files (PC required for creating DivX® discs)
- Digital Key Controller for changing the key of the music to fit your vocal range
- Built in Dolby Digital (AC-3) and Dolby DTS decoders for cinema sound quality
- Full-function remote control for ease of operation of all system features
- Audio Outputs 5.1 Channel, Stereo L/R, Digital Coaxial, Digital Optical
- Video Outputs: Y, Cb, Cr, Composite RCA, S-Video
- 100V/240V and NTSC-PAL compatible for use worldwide

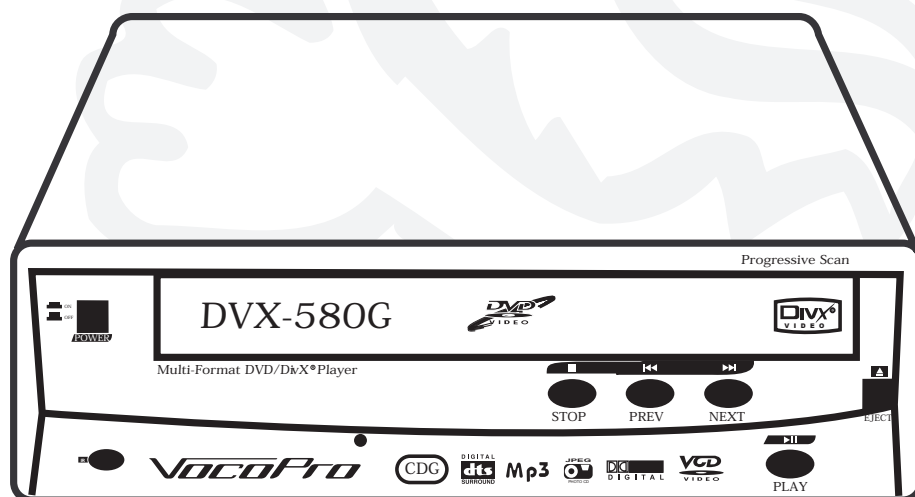

DVX-580G

o w n e r ' s m a n u a l

Safety Instructions



CAUTION RISK OF SHOCK



CAUTION: To reduce the risk of electric shock, do not remove cover (or back). No user-serviceable parts inside. Only refer servicing to qualified service personnel.

Explanation of Graphical Symbols



The lightning flash & arrowhead symbol, within an equilateral triangle, is intended to alert you to the presence of danger.



The exclamation point within an equilateral triangle is intended to alert you to the presence of important operating and servicing instructions.

WARNING

To reduce the risk of fire or electric shock, do not expose this unit to rain or moisture.

1. Read Instructions - All the safety and operating instructions should be read before the appliance is operated.

2. Retain Instructions - The safety and operating instructions should be retained for future reference.

3. Heed Warnings - All warnings on the appliance and in the operating instructions should be adhered to.

4. Follow Instructions - All operating and use instructions should be followed.

5. Attachments - Do not use attachments not recommended by the product manufacturer as they may cause hazards.

6. Water and Moisture - Do not use this unit near water. For example, near a bathtub or in a wet basement and the like.

7. Carts and Stands - The appliance should be used only with a cart or stand that is recommended by the manufacturer.

7 A. An appliance and cart combination should be moved with care. Quick stops, excessive force, and uneven surfaces may cause an overturn.



8. Ventilation - The appliance should be situated so its location does not interfere with its proper ventilation. For example, the appliance should not be situated on a bed, sofa, rug, or similar surface that may block the ventilation slots.

9. Heat - The appliance should be situated away from heat sources such as radiators, heat registers, stoves, or other appliances (including amplifiers) that produce heat.

10. Power Sources - The appliance should be connected to a power supply only of the type described in the operating instructions or as marked on the appliance.

11. Grounding or Polarization - Precautions should be taken so that the grounding or polarization means of an appliance is not defeated.

12. Power-Cord Protection - Power-supply cords should be routed so that they are not likely to be walked on or pinched by items placed upon or against them, paying particular attention to cords at plugs, convenience receptacles, and the point where they exit from the appliance.

13. Cleaning - Unplug this unit from the wall outlet before cleaning. Do not use liquid cleaners or aerosol cleaners. Use a damp cloth for cleaning.

14. Power lines - An outdoor antenna should be located away from power lines.

15. Nonuse Periods - The power cord of the appliance should be unplugged from the outlet when left unused for a long period of time.

16. Object and Liquid Entry - Care should be taken so that objects do not fall and liquids are not spilled into the enclosure through openings.

17. Damage Requiring Service - The appliance should be serviced by qualified service personnel when:

- A. The power supply cord or plug has been damaged; or
- B. Objects have fallen into the appliance; or
- C. The appliance has been exposed to rain; or
- D. The appliance does not appear to operate normally or exhibits a marked change in performance; or
- E. The appliance has been dropped, or the enclosure damaged.

18. Servicing - The user should not attempt to service the appliance beyond that described in the operating instructions. All other servicing should be referred to qualified service personnel.

Note:

To CATV system installer's (U.S.A.): This reminder is provided to call the CATV system installer's attention to Article 820-40 of the NEC that provides guidelines for proper grounding and, in particular, specifies that the cable ground shall be connected as close to the point of cable entry as practical.

FCC INFORMATION (U.S.A.)

1. IMPORTANT NOTICE: DO NOT MODIFY THIS

UNIT!: This product, when installed as indicated in the instructions contained in this manual, meets FCC requirements. Modifications not expressly approved by Vocopro may void your authority, granted by the FCC, to use this product.

2. IMPORTANT: When connecting this product to accessories and/or another product use only high quality shielded cables. Cable(s) supplied with this product **MUST** be used. Follow all installation instructions. Failure to follow instructions could void your FCC authorization to use this product in the U.S.A.

3. NOTE: This product has been tested and found to comply with the requirements listed in FCC Regulations, Part 15 for Class "B" digital devices. Compliance with these requirements provides a reasonable level of assurances that your use of this product in a residential environment will not result in harmful interference with other electronic devices. This equipment generates/uses radio frequencies and, if not installed and used according to the instructions found in the owner's manual, may cause interference harmful to the operation of other electronic devices. Compliance with FCC regulations does not guarantee that interference will not occur in all installations. If this product is found to be the source of interference, which can be determined by turning the unit "Off" and "On", please try to eliminate the problem by using one of the following measures:

Relocate either this product or the device that is being affected by the interference.

Use power outlets that are on different branch (circuit breaker or fuse) circuits or install AC line filter(s).

In the case of radio or TV interference, relocate/reorient the antenna. If the antenna lead-in is 300-ohm ribbon lead, change the lead-in to coaxial type cable.

If these corrective measures do not produce satisfactory results, please contact your local retailer authorized to distribute Vocopro products. If you can not locate the appropriate retailer, please contact Vocopro, 1728 Curtiss Court, La Verne, CA 91750.

CAUTION

The apparatus is not disconnected from the AC power source so long as it is connected to the wall outlet, even if the apparatus itself is turned off. To fully insure that the apparatus is indeed fully void of residual power, leave unit disconnected from the AC outlet for at least fifteen seconds.

CAUTION:

READ THIS BEFORE OPERATING YOUR UNIT

1. To ensure the finest performance, please read this manual carefully. Keep it in a safe place for future reference.
2. Install your unit in a cool, dry, clean place - away from windows, heat sources, and too much vibration, dust, moisture or cold. Avoid sources of hum (transformers, v motors). To prevent fire or electrical shock, do not expose to rain and water.
3. Do not operate the unit upside-down.
4. Never open the cabinet. If a foreign object drops into the set, contact your dealer.
5. Place the unit in a location with adequate air circulation. Do not interfere with its proper ventilation; this will cause the internal temperature to rise and may result in a failure.
6. Do not use force on switches, knobs or cords. When moving the unit, first turn the unit off. Then gently disconnect the power plug and the cords connecting to other equipment. Never pull the cord itself.
7. Do not attempt to clean the unit with chemical solvents: this might damage the finish. Use a clean, dry cloth.
8. Be sure to read the "Troubleshooting" section on common operating errors before concluding that your unit is faulty.
9. This unit consumes a fair amount of power even when the power switch is turned off. We recommend that you unplug the power cord from the wall outlet if the unit is not going to be used for a long time. This will save electricity and help prevent fire hazards. To disconnect the cord, pull it out by grasping the plug. Never pull the cord itself.
10. To prevent lightning damage, pull out the power cord and remove the antenna cable during an electrical storm.
11. The general digital signals may interfere with other equipment such as tuners or receivers. Move the system farther away from such equipment if interference is observed.

NOTE:

Please check the copyright laws in your country before recording from records, compact discs, radio, etc. Recording of copyrighted material may infringe copyright laws.

Voltage Selector (General Model Only)

Be sure to position the voltage selector to match the voltage of your local power lines before installing the unit.

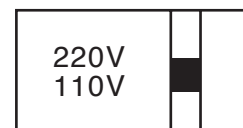



Welcome...



And Thank you for purchasing the DVX-580G from VocoPro, your ultimate choice in Karaoke entertainment! With years of experience in the music entertainment business, VocoPro is a leading manufacturer of Karaoke equipment, and has been providing patrons of bars, churches, schools, clubs and individual consumers the opportunity to sound like a star with full-scale club models, in-home systems and mobile units. All our products offer solid performance and sound reliability, and to further strengthen our commitment to customer satisfaction, we have customer service and technical support professionals ready to assist you with your needs. We have provided some contact information for you below.

VocoPro

1728 Curtiss Court
La Verne, CA 91750
Toll Free: 800-678-5348
TEL: 909-593-8893
FAX: 909-593-8890

VocoPro Company Email Directory

Customer Service & General Information

info@vocopro.com

Tech Support

techsupport@vocopro.com

Remember Our Website

Be sure to visit the VocoPro website **www.vocopro.com** for the latest information on new products, packages and promos. And while you're there don't forget to check out our Club VocoPro for Karaoke news and events, chat rooms, club directories and even a KJ Service directory!

We look forward to hearing you sound like a PRO, with VocoPro, your ultimate choice in Karaoke entertainment.

FOR YOUR RECORDS

Please record the model number and serial number below, for easy reference, in case of loss or theft. These numbers are located on the rear panel of the unit. Space is also provided for other relevant information

Model Number _____

Serial Number _____

Date of Purchase _____

Place of Purchase _____

Listening For A Lifetime

Selecting fine audio equipment such as the unit you've just purchased is only the start of your musical enjoyment. Now it's time to consider how you can maximize the fun and excitement your equipment offers. VocoPro and the Electronic Industries Association's Consumer Electronics Group want you to get the most out of your equipment by playing it at a safe level. One that lets the sound come through loud and clear without annoying blaring or distortion and, most importantly, without affecting your sensitive hearing.

Sound can be deceiving. Over time your hearing 'comfort level' adapts to a higher volume of sound. So what sounds 'normal' can actually be loud and harmful to your hearing. Guard against this by setting your equipment at a safe level BEFORE your hearing adapts.

To establish a safe level:

- ĩ Start your volume control at a low setting.
- ĩ Slowly increase the sound until you can hear it comfortably and clearly, and without distortion.

Once you have established a comfortable sound level:

- ĩ Set the dial and leave it there.
- ĩ Pay attention to the different levels in various recordings.

Taking a minute to do this now will help to prevent hearing damage or loss in the future. After all, we want you listening for a lifetime.

Used wisely, your new sound equipment will provide a lifetime of fun and enjoyment. Since hearing damage from loud noise is often undetectable until it is too late, this manufacturer and the Electronic Industries Association's Consumer Electronics Group recommend you avoid prolonged exposure to excessive noise. This list of sound levels is included for your protection.

Some common decibel ranges:

Level	Example
30	Quiet library, Soft whispers
40	Living room, Refrigerator, Bedroom away from traffic
50	Light traffic, Normal Conversation
60	Air Conditioner at 20 ft., Sewing machine
70	Vacuum cleaner, Hair dryer, Noisy Restaurant
80	Average city traffic, Garbage disposals, Alarm clock at 2 ft.

The following noises can be dangerous under constant exposure:

Level	Example
90	Subway, Motorcycle, Truck traffic, Lawn Mower
100	Garbage truck, Chainsaw, Pneumatics drill
120	Rock band concert in front of speakers
140	Gunshot blast, Jet plane
180	Rocket launching pad

-Information courtesy of the Deafness Research Foundation

CONTENTS

INTRODUCTION

Safety Instructions	2
FCC Information	3
Welcome	4
Listening for a Lifetime	5
Table of Contents	6
Media supported by your DVX-580G.....	7
The DivX breakthrough	7

DESCRIPTIONS AND FUNCTIONS

Front panel	8
Rear panel.....	8
Remote control	9-10

GETTING STARTED

Connecting to an analog amplifier/2 channel stereo receiver mixer	11
Connecting to a TV with RCA connections.....	11
Connecting to a TV using an RF modulator	11
Connecting to a TV through a VCR.....	12
Connecting to a TV with S-Video inputs.....	12
Connecting to a TV with Y Cb Cr Component Video inputs.....	12
Connecting to HDTV.....	13
Connecting to a Dolby Digital system/DTS receiver/decoder	13
Connecting to Dolby Pro Logic amplifier.....	13
Connecting to DTS receiver/decoder.....	14
Connecting to both analog and digital audio.....	14

SETTING UP PREFERENCES

General setup	15
Speaker setup.....	16
Audio setup.....	17-18
Karaoke setup.....	18
Preferences setup	19

BASIC OPERATIONS

Play	20
Stop play	20
Pause	20
Fast forward/rewind	20
Frame advance	20
Slow/fast playback.....	20

ADVANCED OPERATIONS

Scene/track selection	21
Searching by scene/track.....	21
Searching by time	21
Zooming.....	21
Subtitles and choosing language	21
Changing angles	22
Repeat playback	22
Program play	22

MP3 FUNCTIONS AND OPERATIONS

General notes on MP3 discs	23
Notes on playing MP3 discs.....	23
Display indications during playback	23
Notes on creating MP3 discs.....	23
MP3 Glossary.....	23
MP3 play mode	23
MP3 Functions and operations	24

DivX OPERATIONS

Requirements.....	25
Downloads.....	25
Ripping CDs/AVI conversion	25

SPECIFICATIONS

Specifications	26
----------------------	----

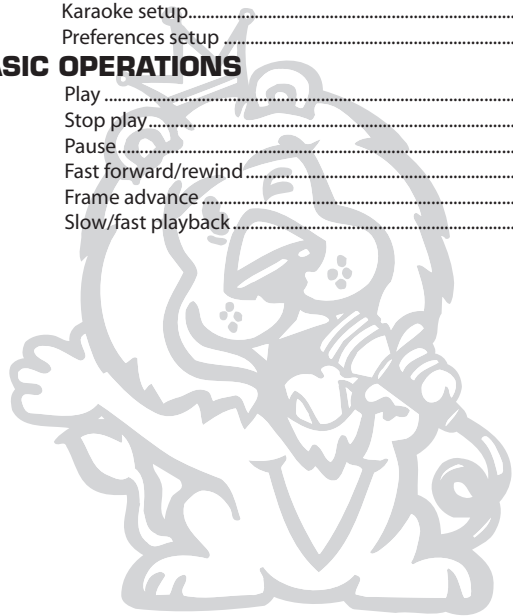

VocoPro

ULTIMATE CHOICE OF KARAOKE ENTERTAINMENT

The DivX Breakthrough

What audiophile or music lover wouldn't rather compile hours of their favorite music on a single disc instead of worrying about keeping a disc-changer constantly refreshed? Wouldn't you love to load a disc in your player and not have worry about about changing it until you've listened to literally hundreds of CD-quality songs or burn DVD-quality videos on a single data CD? Think of what that could do for archiving hours of your own home videos in a fraction of the space they take up now! Likewise, for a long time, every Karaoke party has required a large CD library just to have enough tracks to entertain everyone, having to change discs often to keep the action going. Standard CDs or CD+Gs just don't offer enough tracks, and even MP3 discs are limiting. Fortunately, DivX Networks, Inc, an independent company,* has provided an alternative with their cutting edge compression software utilizing MPEG4 technology.

DivX is analogous for Digital Video what the MP3 was for audio, which means it is capable of advancing all audio and video applications, including Karaoke entertainment. VocoPro recognized the incredible breakthrough that DivX offered our consumers, so we developed our latest series of players to support DivX discs. Your new DVX-580G is designed with your multi-purpose home entertainment in mind--a player that can do it all. You will see that creating DivX discs which compile volumes of your recordings and videos is simple. With a PC and two easy downloads, you will be ready to archive your audio and videos libraries. See the "DivX operations" section of this manual for more information, and in the meantime, start enjoying all the other features of your DVX-580G!

*DivX Networks and subsidiaries is not affiliated with VocoPro and VocoPro accepts no responsibility for DivX Networks products. DivX software is third-party paid (some applications are free for a limited time only), and all inquiries regarding DivX should be directed to www.divx.com.

Media supported by your DVX-580G

CD
DVD
DivX
CD-R
CD-RW
VCD 1.0/1.1/2.0
HDCD
MP3
WMA
DVD5 (single-sided, single layer)
DVD9 (single-sided, dual layer)
DVD10 (dual-sided, single layer)
DVD18 (dual-sided, dual layer)
SVCD
CVD
DVCD
CD-DA
SACD

Regions and codes:

- 1 - USA, Canada
- 2 - European countries, Japan, Middle East, South Africa
- 3 - West Asia (South Korea, Hong Kong, Taiwan), Southeast Asia
- 4 - Australia, Caribbean, Mexico, New Zealand
- 5 - Africa, Russia, India, North Korea, Pakistan
- 6 - Mainland China

Note on purchasing DVD discs: DVD discs like DVD players have a code of region. A DVD player can only play DVD discs that conform to its region code.

Ask your DVD disc dealer to confirm that their DVD discs are consistent with your region code.

Descriptions and Functions

FRONT

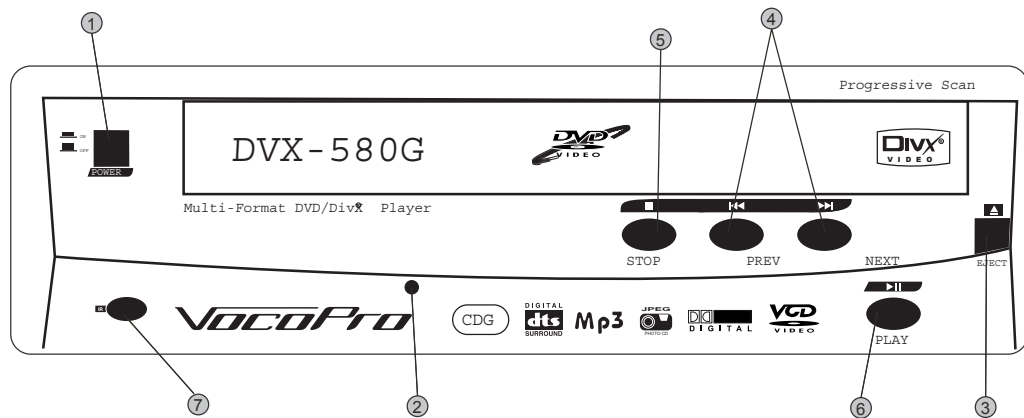

REAR

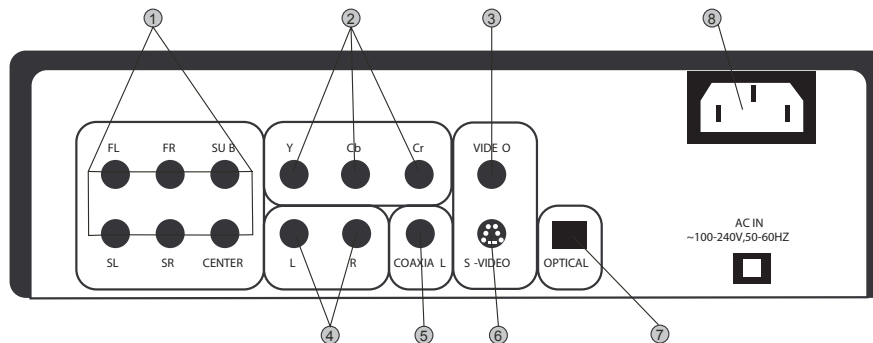

FRONT

1. **POWER** button - This button turns the unit ON/OFF.
2. **LED** indicator - This light will illuminate red when unit is powered ON.
3. **EJECT** button - Used to OPEN/CLOSE disc trays.
4. **PREV / NEXT** buttons - Press these buttons to advance to the NEXT or reverse to the PREVIOUS track.
5. **STOP** - Press once to PAUSE playback and enter AUTO STOP MODE. Press twice to STOP playback. When in AUTO STOP MODE, playback pauses and the VocoPro screen appears. Pressing PLAY will resume playback and exit AUTO STOP MODE.
6. **PLAY / PAUSE** button - This button is used to initiate disc PLAYBACK.
7. **REMOTE SENSOR** - This sensor receives infrared signals transmitted by the REMOTE CONTROL transmitter. Obstacles located between the remote control and remote sensor should be avoided as they can prevent signal recognition.

REAR

1. **5.1 CH. AUDIO OUTPUT** jacks - These jacks are for connecting to 5.1 channel ready amplifiers/receivers.
2. **COMPONENT VIDEO OUT** (Y/Pb/Pr) jacks - These jacks output VIDEO to a TV or monitor via COMPONENT VIDEO cables. COMPONENT VIDEO outputs the different color signals (Pr/Pb) and luminance signal (Y) separately in order to achieve high fidelity in reproducing colors. The description of the component video output connectors may differ depending on the TV set or monitor (e.g. Pr/Pb Y, Cr/Cb/Y, R-Y/B-Y/Y, etc.). Please refer to the operating instructions of the TV set or monitor for details.
3. **VIDEO OUT** (RCA) jack - This jack outputs VIDEO to TVs, TFTs and monitors.
4. **AUDIO OUT** (RCA) jacks - These audio output jacks provide analog AUDIO connections to external devices (A/V receivers, TVs, VCRs etc.)
5. **COAXIAL OUT** jack - This digital output is for connecting devices with a COAXIAL cable.
6. **S-VIDEO** jack - This jack outputs VIDEO to a display device (TV, TFT, etc.) via an S-VIDEO cable. S-VIDEO provides better color separation and better resolution by separating the color and picture signals of a composite-video signal.
7. **OPTICAL OUT** jack - This digital out is for connecting devices with an OPTICAL cable. Please make sure to remove the protective cover from this jack prior to connecting an OPTICAL cable. When not using this input, keep the protective cover on to protect it from dust and foreign material.
8. **AC IN terminal** - Grounded AC power cable connects here.

Remote Control

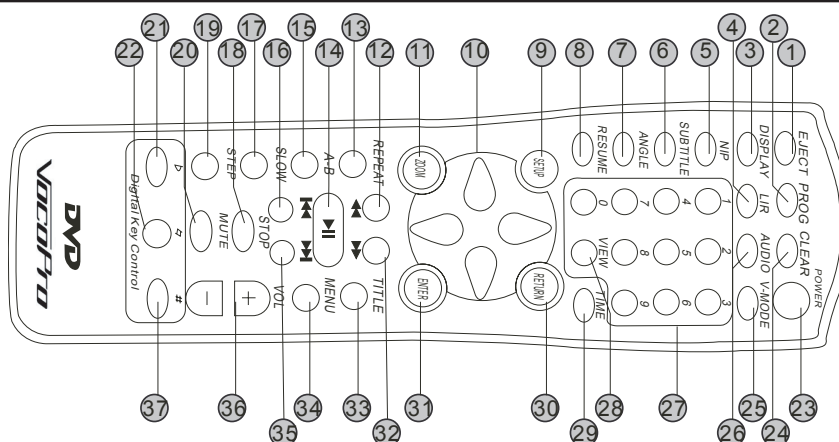

- 1 **OPEN/CLOSE** button - Press to OPEN and CLOSE the disc tray.
- 2 **PROGRAM** button - Press to access the PROGRAM selection window.
- 3 **DISPLAY** button - To access OSD playback displays menu. The different OSD display modes available depend on the type of disc being played.
- 4 **L/R** - Will allow you to select between five playback modes for CDGs and VCDs: LEFT VOCAL, RIGHT VOCAL, MONO LEFT (for Vocal Cancel), MONO RIGHT and STEREO mode. In STEREO mode, audio playback is standard L/R audio. In MONO LEFT mode the right, guide vocal channel is removed, and replaced with a duplicate, instrmental left channel. In MONO R mode, the left channel is removed, and replaced with a duplicate right channel of all vocals.
- 5 **N/P** - Press to toggle between NTSC and PAL video settings. Select NTSC for North American base video systems and PAL for European based video systems.
- 6 **SUBTITLE** - Press to access the SUBTITLE selection window.
- 7 **ANGLE** - For use only with multi angle coded discs, for example some recorded performances such a sports events, concerts or theatrical programs. Pressing button will select various angles for view
- 8 **RESUME** - Returns you to track listing menu from any SETUP subdirectory.
- 9 **SETUP** - Press to access the main setup MENU.
- 10 **DIRECTION** keys - Use these buttons to navigate through the various menu selections
- 11 **ZOOM** - Increases the size of the Lyrics display during TRACK playback, or the SCENE view on DVD.
- 12 **REVERSE** - Rewinds through current TRACK, or SCENE. Each time button is pressed, speed will increase; for example, 2X, 4X, 6X, 8X.
- 13 **REPEAT** - Press once to access the REPEAT selection window, press twice to select TRACK REPEAT mode and press a third time to select DISC REPEAT mode.
- 14 **PLAY / PAUSE** button - Press to initiate disc PLAYBACK or PAUSE disc playback.
- 15 **A-B button** - This feature creates a segment of a TRACK/SCENE to "loop" or repeat. Press once to set the A-MARKER where the loop will begin. Press a second time to set the B-MARKER where the loop will end. The loop will start immediately after you set the B-MARKER. Press a third time to CANCEL the A-B loop and resume normal play.
- 16 **PREVIOUS** - Returns to the PREVIOUS track, scene or file.
- 17 **SLOW** - Press to execute a SLOW motion playback of a DVD or Video CD.
- 18 **STOP** button - Press this button once to PAUSE playback and enter AUTO STOP MODE. Press twice to completely STOP playback. While in AUTO STOP MODE, playback pauses and the VocoPro splash screen appears. Pressing PLAY will resume playback and exit AUTO STOP MODE.
- 19 **STEP** - Press this button to enter STEP mode playback. In STEP mode, playback is paused and the track/scene advances only a single each time STEP is pressed. To exit STEP mode, hit the ENTER/PLAY button.
- 20 **MUTE** button - Press to SILENCE audio playback. Video playback is not affected while using the menu feature.
- 21 **b (FLAT)** Key Control button - Will LOWER key of music output a 1/2 step.
- 22 **p (NATURAL)** Key Control button - Will return music output to its original, or NATURAL key.
- 23 **POWER** button - Press to turn machine ON/OFF.
- 24 **CLEAR** - Cancels PROGRAM function.
- 25 **V-MODE** - To select video signal output selections for S-VIDEO, INTERLACED TV, COAXIAL or Y,CB,CR.
- 26 **AUDIO** - For use with DVD only to select languages or switch to 5.1 channel output.
- 27 **NUMBER** pad - Press to select a track or file for direct playback.
- 28 **VIEW** - When using VCDs, this button will give you 4 options: INTRO, DISC, TRACK and EXIT. The 3 menus will show up to 9 TRACKS or sections to view.
- 29 **TIME** - Press this button to view the CURRENT DISC/TRACK POSITION and/or to manually input a TIME MARKER to start playback from.
- 30 **RETURN** - For use with VCDs, this button will return to previous menu or page
- 31 **ENTER** - To make menu selections, play selected tracks
- 32 **FORWARD** - Advances through current TRACK or SCENE. Each time button is pressed, speed will increase. It is also possible to advance to the next TRACK if button is pressed several times.
- 33 **TITLE** - Press to access the TITLE MENU of a DVD, VCD or media disc. Press again to return back to disc playback. If the TITLE MENU button is pressed during disc playback, playback is paused. Upon exiting the TITLE MENU, playback is resumed.
- 34 **MENU** - Press to access a DIGEST or TITLE WINDOW of a DVD, VCD or media disc. Press again to return back to disc playback. If the MENU button is pressed during disc playback, playback is paused. Upon exiting the MENU window, playback is resumed.
- 35 **NEXT** - Advances to the NEXT track, scene or file.
- 36 **VOLUME +/-** keys - Press this button to RAISE or LOWER the master music VOLUME.
- 37 **# (SHARP)** Key Control button - Will RAISE key of music output a 1/2 step.

Remote Control Operations

Installing the batteries

To install the batteries, first remove the battery compartment lid from the back of the remote control. Insert two AA batteries, ensuring that the polarities are aligned correctly.

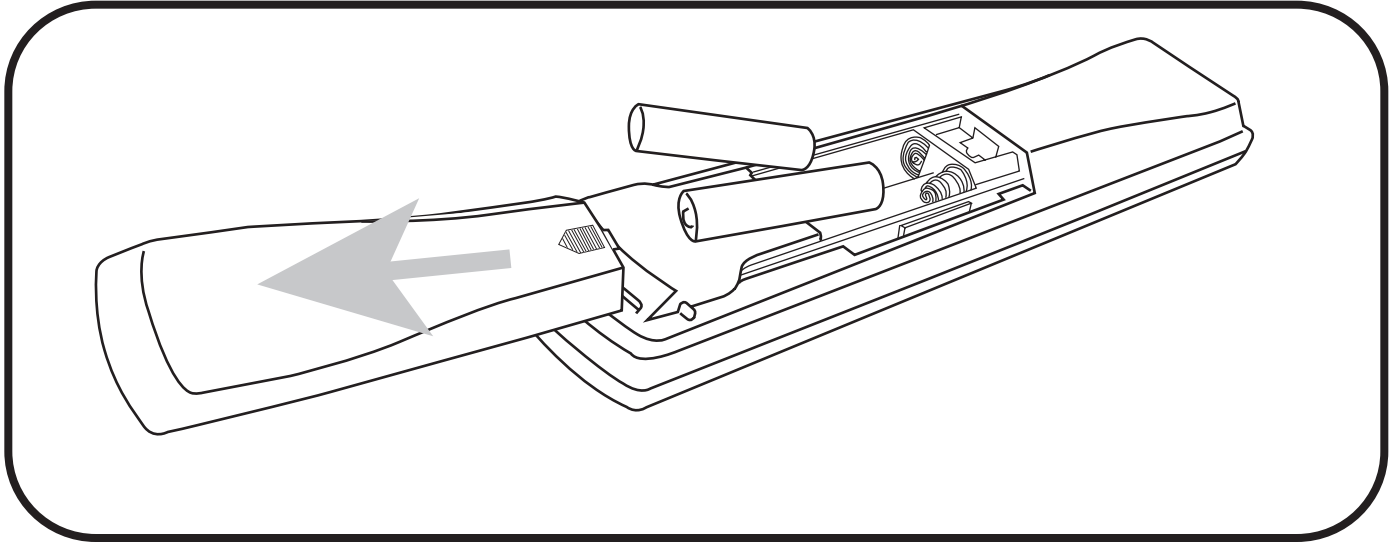

When to replace the batteries

The maximum operational distance between the remote control and the sensor is approximately 23 ft. If this distance decreases, it is time to replace the batteries.

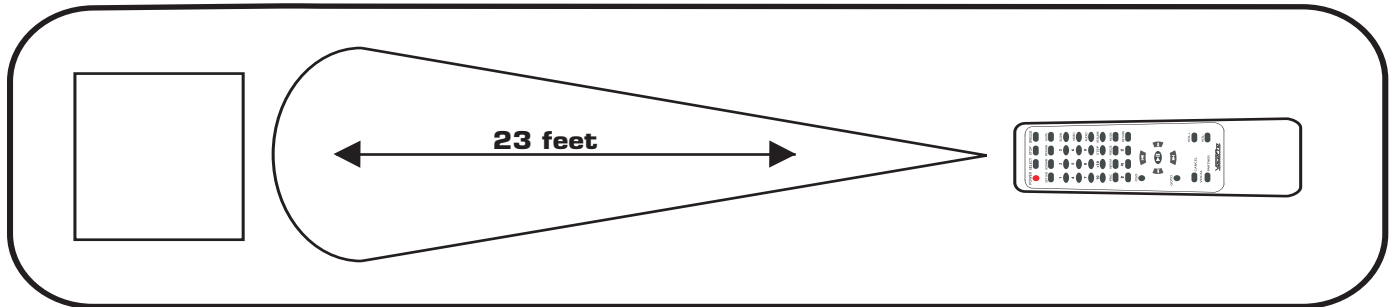

NOTES:

- When operating the remote control, point the top of the remote control toward the player.
- Keep the line of sight between the remote control and player clear of obstacles to prevent signal deflection.
- Do not mix new and old batteries or batteries of different types together.
- Do not use rechargeable batteries with this remote.
- The remote is optimally effective at a range of 20 feet and a 30° angle.

Getting Started

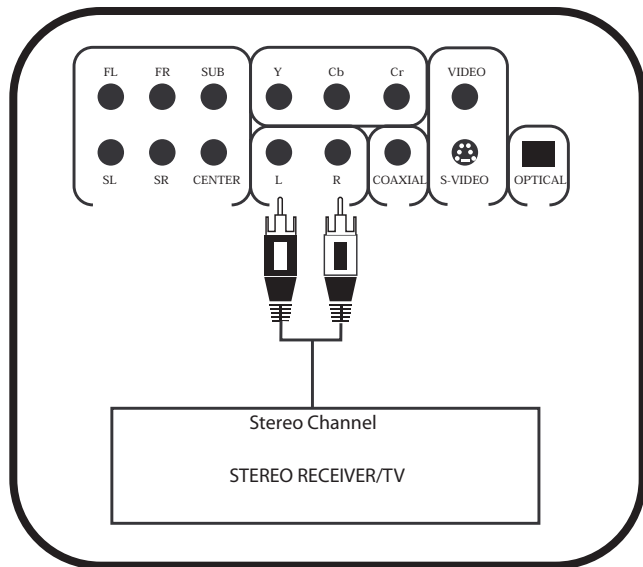

Connecting to an analog amplifier/2-channel stereo receiver/mixer

Using the supplied RCA patch cable, connect one set of red & white RCA plugs to the RCA AUDIO OUTPUT jacks on the DVX-580G. Connect the other set of red & white RCA plugs to the AUDIO INPUT jacks on your stereo receiver/TV.

Depending on the stereo receiver/TV, the audio input jacks may be labeled AUDIO, LINE, AUX, VIDEO 1/2/3.

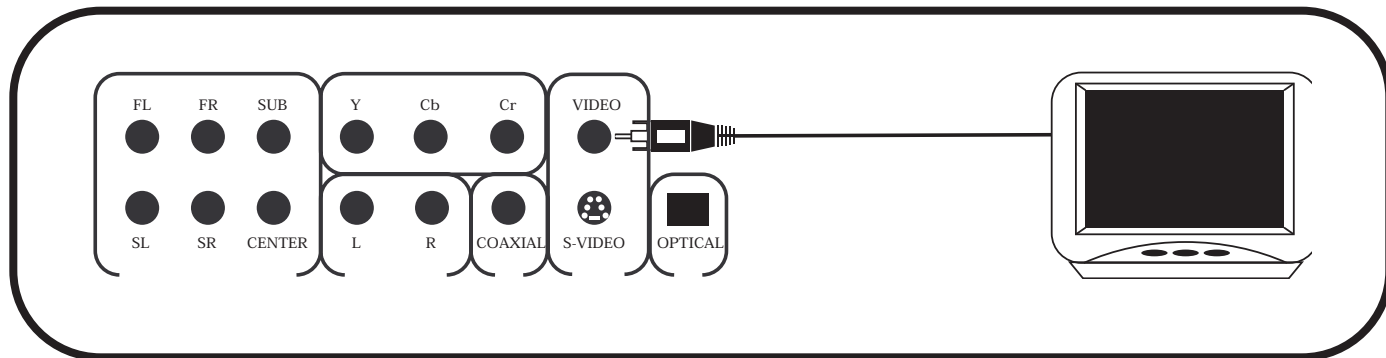

Connecting to a TV with an RCA Connection

Using either the yellow-ended RCA plug from the included RCA patch cable or a separate RCA patch cable, connect one end to the RCA VIDEO OUTPUT jack on the DVX-580G and connect the other end to the VIDEO INPUT jack on our TV or monitor device.

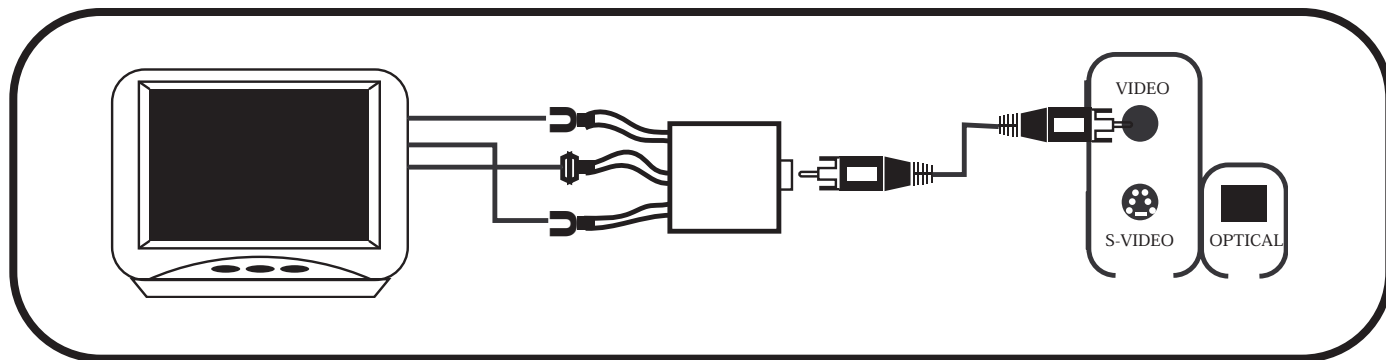

Connecting to a TV with an RF Modulator

If your TV has only a RF-style Jack, such as Antenna In or 75 ohm, and no RCA video input jack, you can connect video with a RF modulator (not supplied). Ask your dealer for details on RF modulator availability and compatibility. Follow the instructions provided with the RF modulator to connect the DVX-580G to your TV. (General model shown as an example).

Getting Started

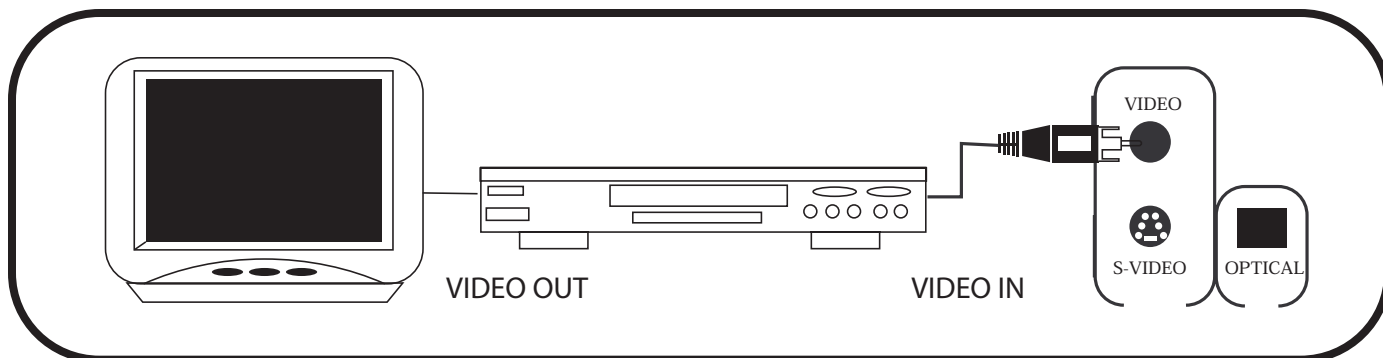

Connecting to a TV with a VCR

You can also use a VCR to connect video to a TV with no RCA video input. You will need an RCA cable and a 75-ohm "coaxial" type cable. Using the RCA video cable, connect one end to the VIDEO OUTPUT jack on the DVX-580G and connect the other end of the cable to the VIDEO INPUT of a VCR. Then, using the 75-ohm "coaxial" type cable, connect one end to the RF OUTPUT of the VCR, and connect the other end to the 75-ohm TV ANTENNA INPUT jack.

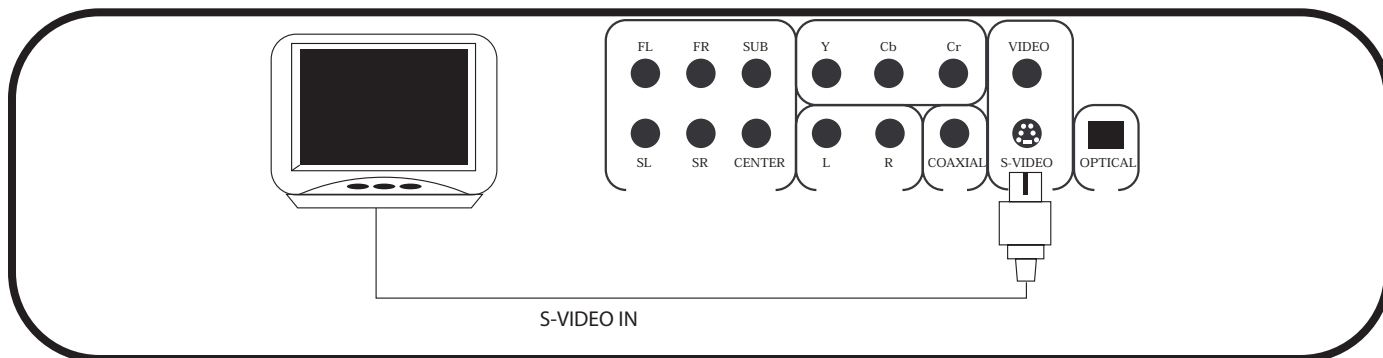

Connecting to a TV with S-Video

Using an S-Video cable, connect one end to the DVX-580G's S-VIDEO OUTPUT jack and connect the other end to the S-VIDEO IN jack on your television.

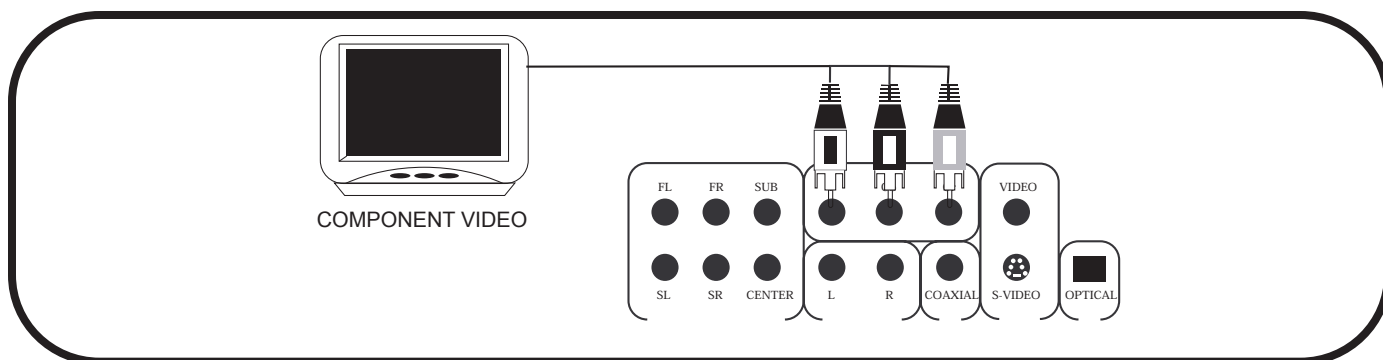

Connecting to a TV with Component Video

Using 3 appropriate Component Video cables (usually color coded red, blue and green), connect a set of plugs to the COMPONENT VIDEO OUT jacks (Y Cb Cr) on the DVX-580G and plug the other set of plugs to your COMPONENT VIDEO IN jacks (Y Cb Cr) on your television.

On some TV's the component video input jacks may be labeled (Y Pb Pr). You will need to press the MODE button on the remote control to toggle between non-interlaced (HDTV) and interlaced (STANDARD) video output. You can only use the MODE button when there is no disc inserted in the disc tray.

Getting Started

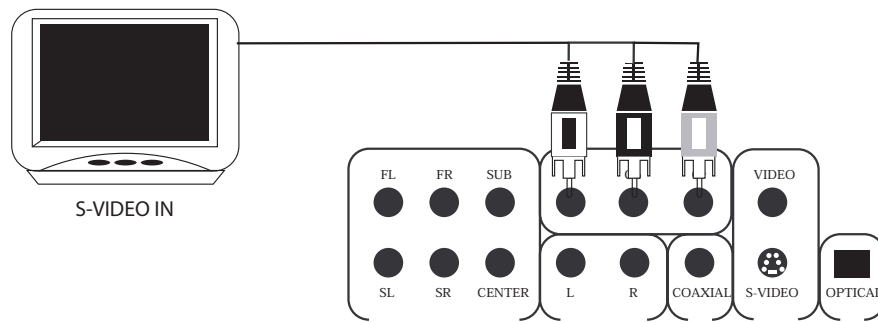

Connecting to a HDTV

To connect video to a HDTV you can use either the same connections as for TV with Component Video. You will need to press the MODE button on the remote control to toggle between non-interlaced (HDTV) and interlaced (STANDARD) video output. You can only use the MODE button when there is no disc inserted in the disc tray.

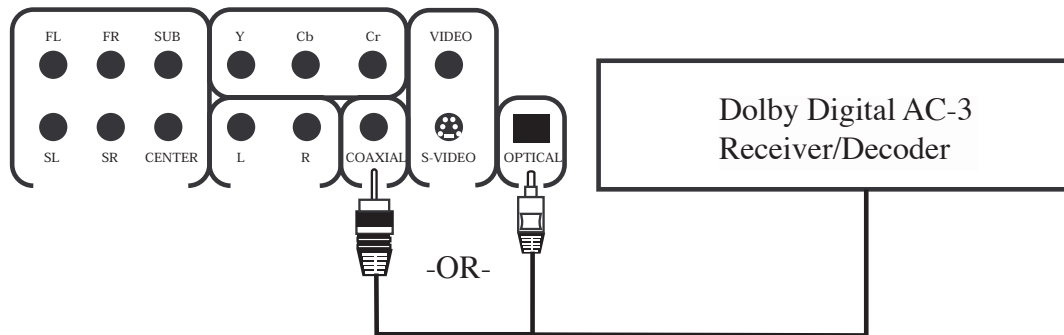

Connecting to a Dolby Digital AC-3 Receiver/Decoder

Using either an RCA-ended COAXIAL cable suited for digital audio use or an OPTICAL cable, connect one end to the appropriate jack on the DVX-580G (Coaxial or Optical) and the other end to the appropriate jack on the AC-3 decoder/receiver (Coaxial or Optical).

If you have both coaxial and optical inputs on your AC-3 decoder/receiver, it is recommended to use an optical connection as those cables eliminate the possibility of EMI (electromagnetic interference).

If your Dolby Digital Receiver does not have a built-in AC-3 decoder, and has 5.1 channel RCA inputs, you can use the 5.1 channel output jacks on the DVX-580G. Either method will provide for AC-3 decoding.

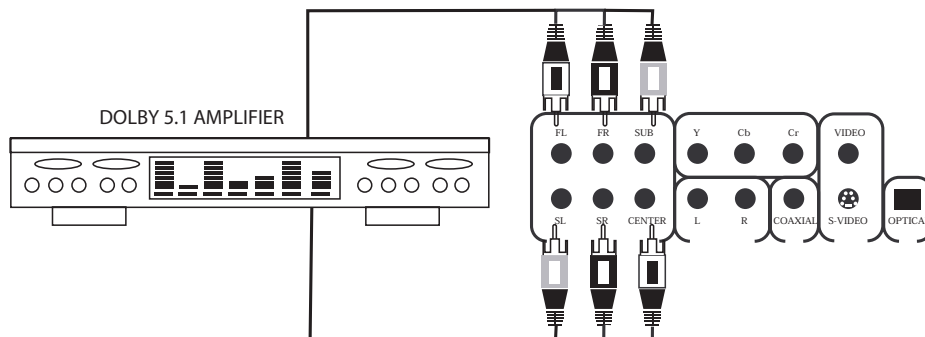

Connecting to a Dolby Pro Logic Amplifier

Using six RCA patch cables, connect the plugs from one side of the cables to the FL, FR, CENTER, SL, SR and SW outputs on the DVX-580G. Connect all the plugs from the other side to the FL, FR, CENTER, SL, SR and SW inputs your Dolby Pro Logic amplifier.

Getting Started

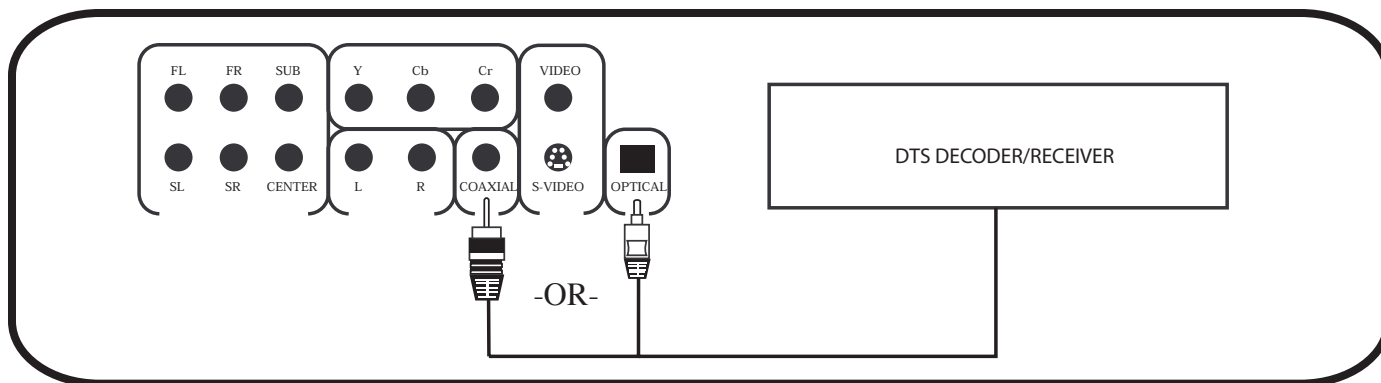

Connecting to a DTS Receiver/Decoder

Using either an RCA-ended COAXIAL cable suited for digital audio use or an OPTICAL cable, connect one end to the appropriate jack on the DVX-580G (Coaxial or Optical) and the other end to the appropriate jack on the DTS receiver (Coaxial or Optical). If you have both coaxial and optical inputs on your DTS decoder/receiver, it is recommended to use an optical connection as those cables eliminate the possibility of EMI (electromagnetic interference). If your DTS receiver does not have a built-in DTS decoder, and has 5.1 channel RCA inputs, you can use the 5.1 channel output jacks on the DVX-580G. Either method will provide for DTS decoding.

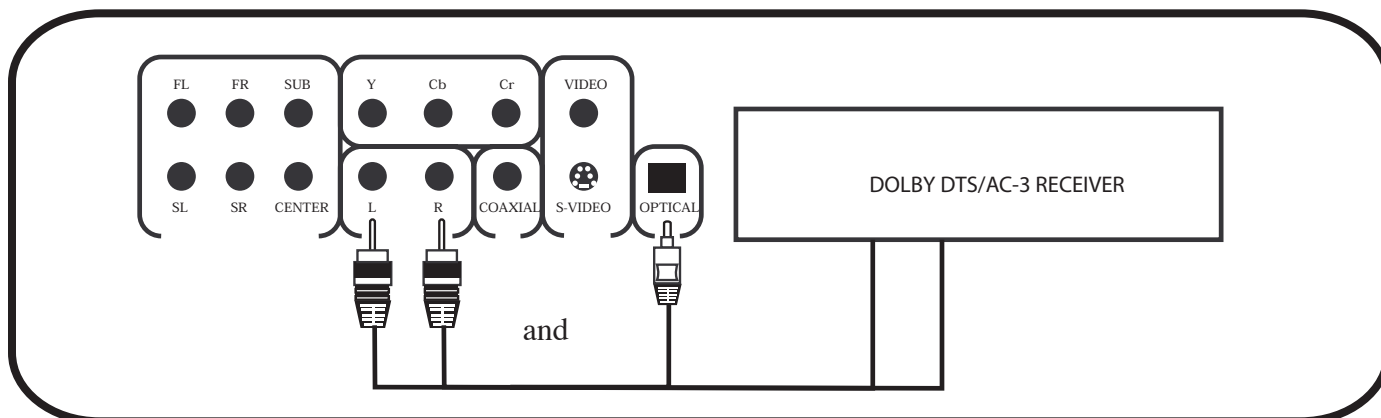

Connecting both Analog and Digital Audio

To do this you will need a Dolby Digital DTS/AC-3 receiver with analog audio inputs. Use optical for video and digital audio and L/R RCA audio for Karaoke features.

SETTING UP PREFERENCES

Press SETUP on the remote control to get into the SETUP menus.

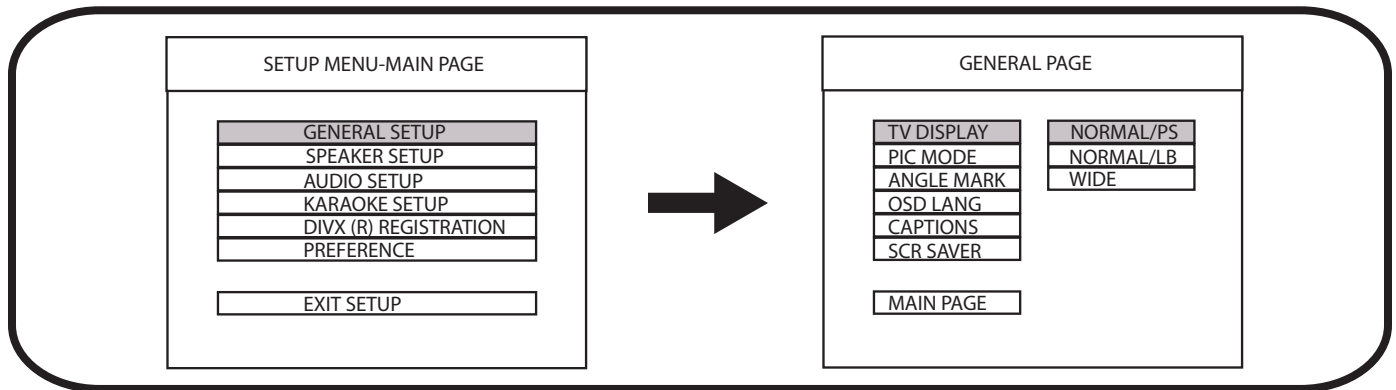

Use direction keys to access desired subdirectories and ON/OFF selections within menus below, then press ENTER when your choice is highlighted.

GENERAL SETUP

Press SETUP on remote control. Make sure the GENERAL SETUP subdirectory in the menu is highlighted and press ENTER.

1. Setting TV DISPLAY mode.

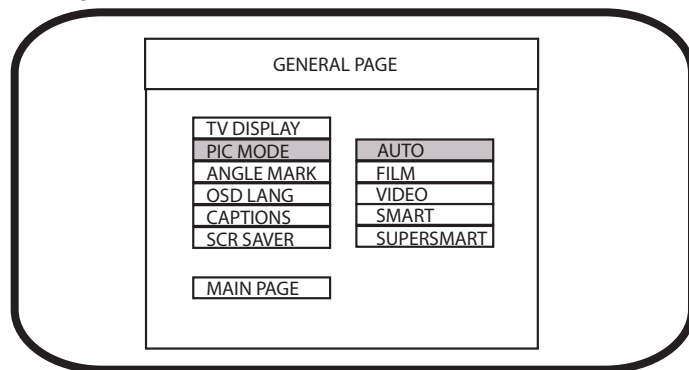

You can choose between NORMAL/PANORAMA, NORMAL/LETTERBOX or WIDE SCREEN display for viewing.

2. Setting PIC MODE.

You can select AUTO and the DVX-580G will automatically recognize the input type, or select FILM, VIDEO or SMART SUPERSMART.

3. Setting ANGLE MARK

When watching certain recorded performances or athletic events, having ANGLE MARK set to ON will allow you to watch the program from different angles. See "Advanced operations" section for more information on this. ANGLE MARK is only applicable to discs which offer changing viewing angle.

4. Setting OSD LANGUAGE

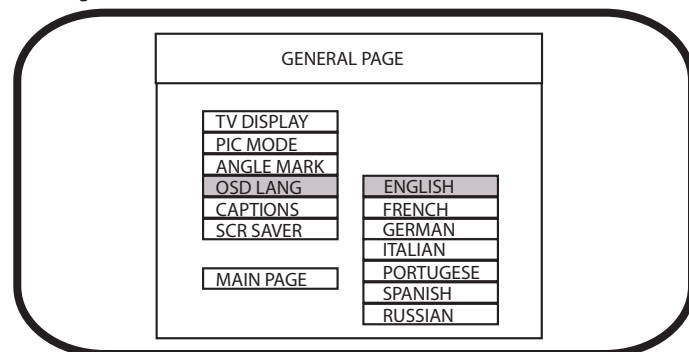

This function allows you to select you screen display language from several options.

5. Setting CAPTIONS

ON to show CAPTIONS, OFF to hide them.

6. Setting SCREEN SAVER

When there is no disc or the player is idle for a period of time, screen saver will appear if this setting is ON.

SETTING UP PREFERENCES

SPEAKER SETUP

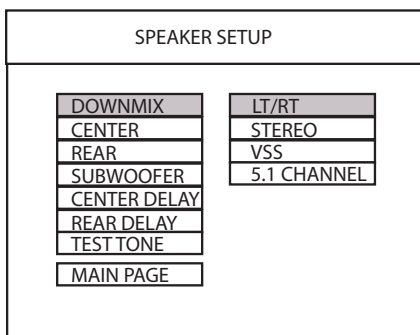

1. DOWNMIX

If the disc has PRO LOGIC Dolby Stereo, select LT/RT. For other stereo, select STEREO.

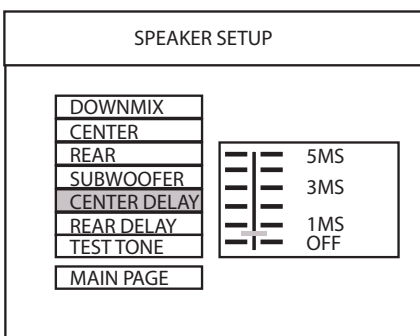

2. CENTER

ON: Center speaker will process audio output signal when playing discs.
OFF: No audio output from center speaker.

3. REAR

ON: LS (Left surround) and RS (right surround) channels active.

OFF: Standard stereo

4. SUBWOOFER

Switch on for subwoofer speaker output.

5. CENTER DELAY

Center signal output can delay for up to 5 milliseconds using fader shown in picture.

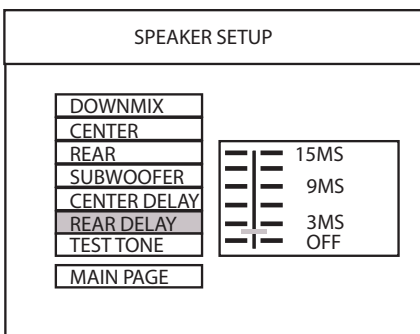

6. REAR DELAY

LS/RS output can delay for 15 milliseconds. using fader shown in picture.

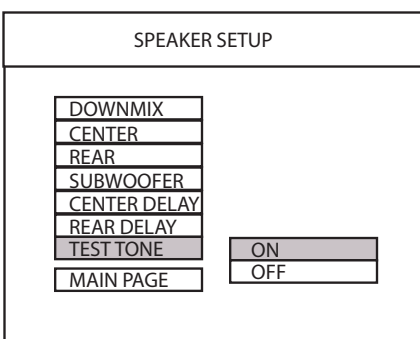

7. TEST TONE

After all channels are set up to your preferences, you can test all output channels by setting TEST TONE to ON.

SETTING UP PREFERENCES

AUDIO SETUP

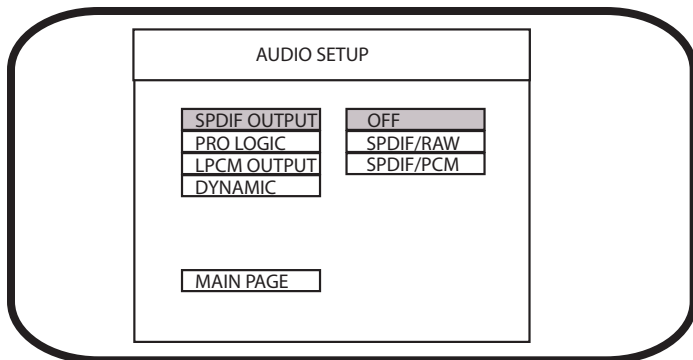

1. SPDIF OUTPUT
 SPDIF/RAW: When using digital output to connect amplifier with Dolby decoding, select this option.
 SPDIF/PCM: When using stereo amplifier to play Dolby digital discs, select this mode.

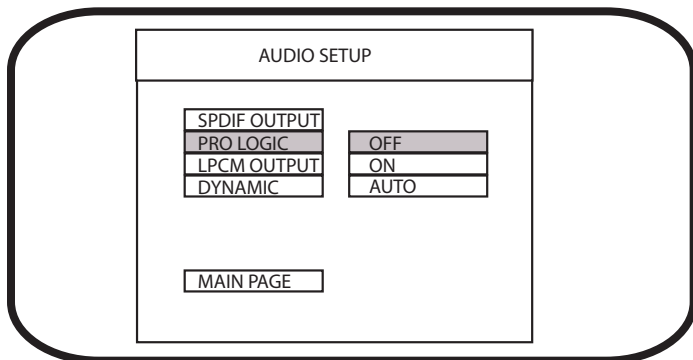

2. PRO LOGIC
 Use to set Dolby surround

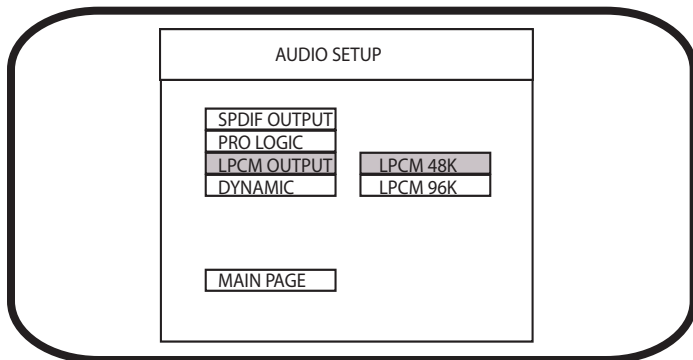

3. LPCM OUTPUT
 Choose between 48KHz or 96KHz. With Karaoke discs (CD+Gs), it is suggested that you use 48KHz. With 96KHz, output may be delayed.

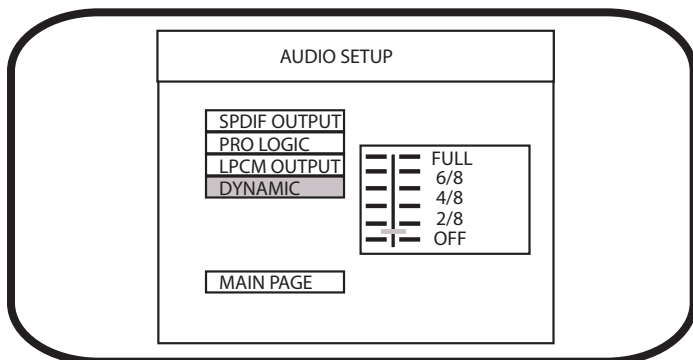

4. DYNAMIC
 You can adjust the line-out ratio for different audio effect. To use this feature, DOWNMIX must be OFF.

SETTING UP PREFERENCES

AUDIO SETUP

5. KARAOKE SETUP

This preference must be set ON to enjoy Digital Key Control (available from the remote control only with the 580G).

Press ENTER when ON is highlighted
To use this feature, DOWNMIX must be OFF.

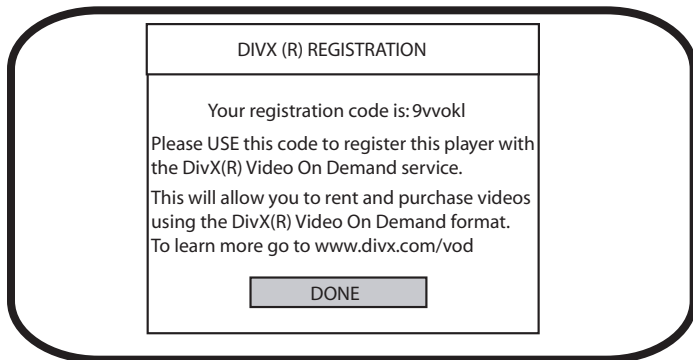

6. DIVX (R) REGISTRATION

Go here to find registration code for www.divx.com Video On Demand services.

SETTING UP PREFERENCES

PREFERENCES

PREFERENCE PAGE	
TV TYPE	MULTI
AUDIO	NTSC
SUBTITLE	PAL
DISC MENU	
PARENTAL	
VIDEO OUTPUT	
PASSWORD	
DEFAULTS	
SETUP MP3	
MAIN PAGE	

SET TV STANDARD

1. TV TYPE

Set to match output to match TV set's system format, for example NTSC for American systems or PAL for European.

PREFERENCE PAGE	
TV TYPE	ENGLISH
AUDIO	FRENCH
SUBTITLE	SPANISH
DISC MENU	CHINESE
PARENTAL	JAPANESE
VIDEO OUTPUT	GERMAN
PASSWORD	INDONESIA
DEFAULTS	RUSSIAN
SETUP MP3	
MAIN PAGE	

PREFERRED AUDIO LANGUAGE

2. AUDIO

Sets language for compatible discs only.

PREFERENCE PAGE	
TV TYPE	ENGLISH
AUDIO	FRENCH
SUBTITLE	SPANISH
DISC MENU	CHINESE
PARENTAL	JAPANESE
VIDEO OUTPUT	GERMAN
PASSWORD	INDONESIA
DEFAULTS	RUSSIAN
SETUP MP3	OFF
MAIN PAGE	

PREFERRED SUBTITLE LANGUAGE

3. SUBTITLE

Select preferred subtitle language.

PREFERENCE PAGE	
TV TYPE	ENGLISH
AUDIO	FRENCH
SUBTITLE	SPANISH
DISC MENU	CHINESE
PARENTAL	JAPANESE
VIDEO OUTPUT	GERMAN
PASSWORD	INDONESIA
DEFAULTS	RUSSIAN
SETUP MP3	
MAIN PAGE	

PREFERRED MENU LANGUAGE

4. DISC MENU

Sets language of menus for compatible discs only.

PREFERENCE PAGE	
TV TYPE	1 G
AUDIO	2
SUBTITLE	3 PG
DISC MENU	4 PG-13
PARENTAL	5
VIDEO OUTPUT	6 PG-R
PASSWORD	7 NC-17
DEFAULTS	ADULT
SETUP MP3	8 NO PARENTAL
MAIN PAGE	

SET PARENTAL CONTROL

5. PARENTAL

You can set passwords to play video discs of any rating. Select rating from list and hit ENTER. You will see INPUT PASSWORD. Use number pad to enter 3308 to access play for that rating.

PREFERENCE PAGE	
TV TYPE	
AUDIO	
SUBTITLE	
DISC MENU	
PARENTAL	
VIDEO OUTPUT	S-VIDEO OUTPUT
PASSWORD	YCB CR OUTPUT
DEFAULTS	YPB PR OUTPUT
SETUP MP3	
MAIN PAGE	

SELECT VIDEO OUTPUT

6. VIDEO OUTPUT

With the DVX-580G, you can select between SVIDEO OUTPUT, YCBCR OUTPUT (Component Video) or YPBPR OUTPUT (Progressive Scan Video).

PASSWORD VERIFY PAGE	
INPUT PASSWORD:	<input type="text"/>
PLEASE ENTER PASSWORD	

7. PASSWORD

To CHANGE PASSWORD, use this menu and type in 3308 to access CHANGE.

8. DEFAULTS

To reset, highlight RESET and press ENTER.

PREFERENCE PAGE	
TV TYPE	
AUDIO	
SUBTITLE	
DISC MENU	
PARENTAL	
VIDEO OUTPUT	
PASSWORD	
DEFAULTS	
SETUP MP3	NO MENU
MAIN PAGE	WITH MENU

SETUP MP3

9. SETUP MP3

You can choose to have an MP3 disc play in a similar mode to a standard disc by choosing NO MENU, or use the SMART NAVI menu to select tracks and PLAY MODE by selecting WITH MENU here.

BASIC OPERATIONS

Playback

Getting ready to play

- Turn on the TV and set its video source (Video 1, Video 3, etc.) to the channel the DVX-580G is connected to.
- Turn on the audio equipment connected to the unit. Set its input source to the channel that the DVX-580G is connected to.

1) Press POWER

When the unit turns on you will see the LED glow red and see the VocoPro screens on your TV.

2) Press OPEN/CLOSE to load CD

3) Load a DISC label side up and press OPEN/CLOSE again to close tray. After the disc tray closes, the disc will automatically start playing. If it does not auto-start, press PLAY.

When loading a DVD, the menu screen may be displayed first for that disc. With CD+G, and other discs, use the <>^# buttons to select the TITLE/CHAPTER or other type of file you want to view, then press ENTER to start viewing or playback.

To stop playback

Press the STOP button.

If the unit is left for 20 minutes without any operations, it will automatically enter STANDBY mode.

If the screensaver is enabled in standby mode, any subsequent operation will cancel it and get you back to a menu.

Discs will continue to spin while the MENU screen is displayed. When you are finished using the unit, turn the power off.

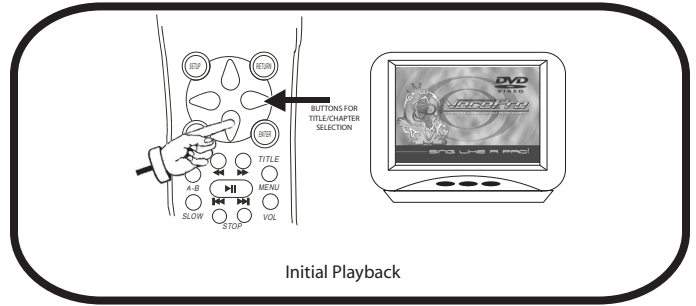

Initial Playback

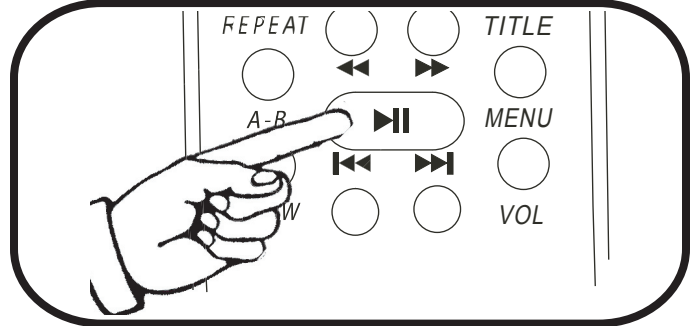

Pausing playback

Press the PLAY/PAUSE key during playback

To return to normal playback

Press PLAY/PAUSE again.

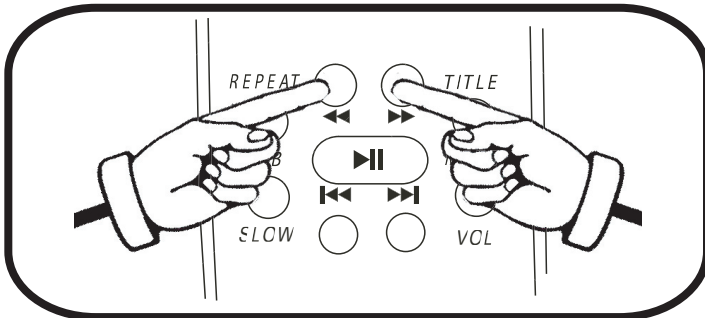

Fast forward/Reverse

Press the <</>> buttons.

Each time you press the << (REVERSE) or >> (FORWARD) button, the search speed increases.

To return to normal playback, press the PLAY button. There is no audio during fast forward/reverse.

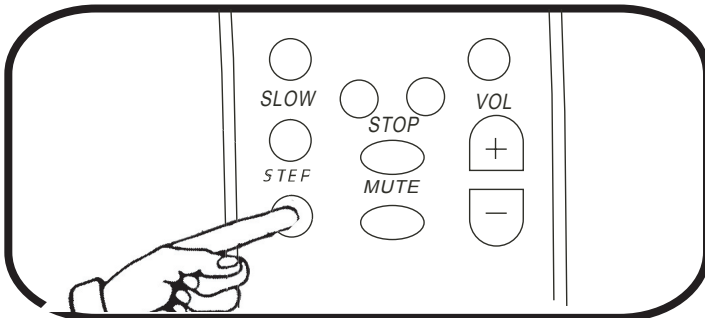

Frame advance

Press STEP during playback.

Each time you press the STEP button, the program advances one frame. There is no audio during STEP playback.

To return to normal playback

Press PLAY.

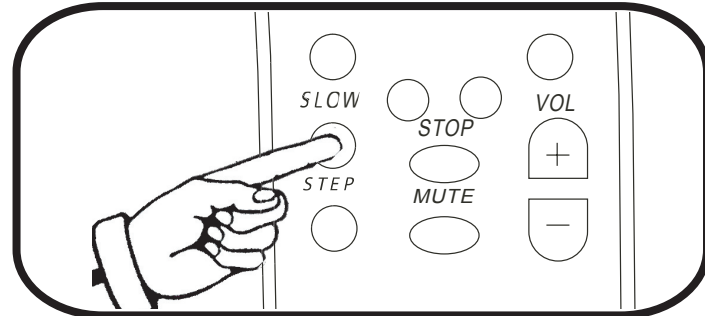

Slow/fast Playback

Press SLOW during playback.

Each time SLOW is pressed, the play speed changes.

There is no audio during SLOW playback. Available SLOW playback speeds differ from DVD to VCD. To return to normal playback, press PLAY.

ADVANCED OPERATIONS

Scene/track selection

To skip to the next chapter or track

Press >>I during playback.

The disc position advances one CHAPTER or TRACK each time the button is pressed.

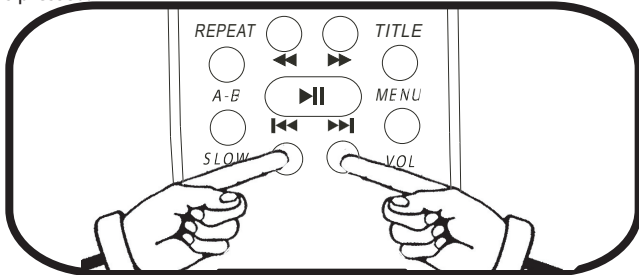

To return to the previous chapter or track

Press the I<< twice in rapid succession to return to the beginning of the previous chapter or track.

To skip to the desired track directly using the number buttons

During playback or in stop mode, press the desired track number using the number pad on the remote control and then ENTER.

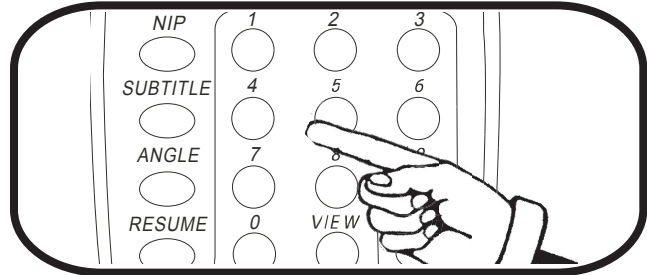

When using these features with a VCD1.1 disc with PBC on, you may be returned to the main menu.

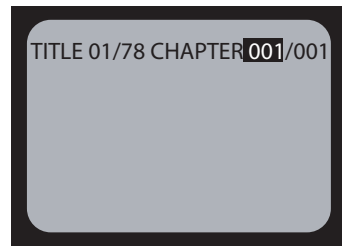
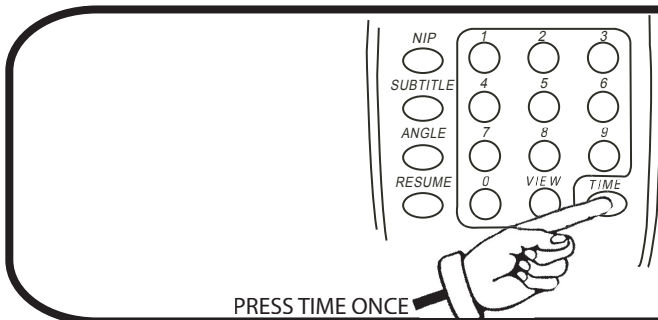

Searching by time

Press TIME during playback.

A TIME search window will appear on screen with an input box for chapters/titles and time. Enter time of desired section using number pad.

To select start time

When at the search window, using the number buttons on the remote control, input the time that you want playback to start from.

Searching by chapter/track

When at the search window, using the number buttons on the remote control, input the numbers for the chapter/track you want to view.

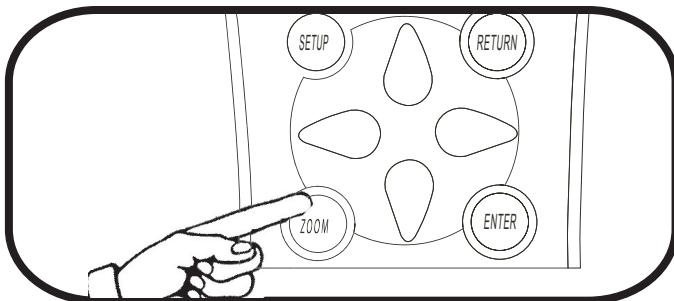

Zooming

The image on the screen is enlarged in steps by pressing the ZOOM button repeatedly. You can move the ZOOM area by using the direction keys. To cancel the ZOOM function, press ZOOM until it cycles back to a normal view.

The zoom function may not work with some discs and when used in conjunction with the SLOW or ANGLE functions.

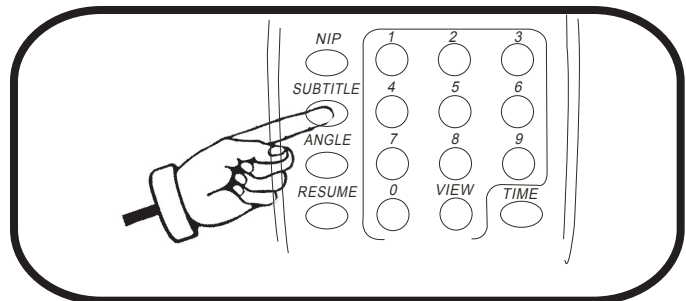

Displaying subtitles and choosing language

Press the SUBTITLE button.

Each time the SUBTITLE button is pressed, a different language will display as the default subtitle language. Subtitle language options are dependent upon the disc manufacturer.

To remove subtitles

Press the SUBTITLE button until subtitles are off.

ADVANCED OPERATIONS

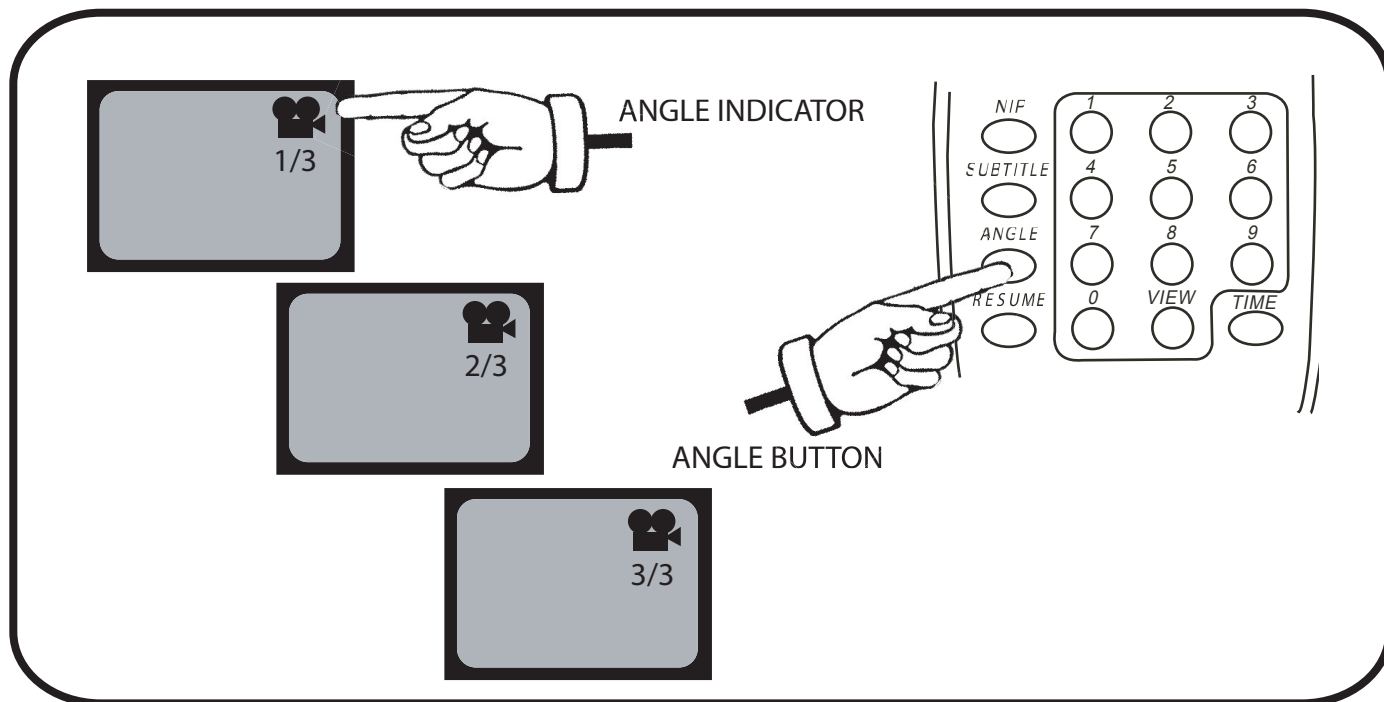

Changing Angles

When playing a DVD with multi-angles recorded, you can select the angle you want to view.

During playback, when a multi-angle scene comes on, the angle symbol is displayed to queue you (I H AVE TO RESEARCH THIS AND FIGURE OUT WHAT THE SYMBOL LOOKS LIKE.)

When you see this option appear, press the ANGLE button to change. Each time ANGLE is pressed, the next available viewing angle is initiated until returning to the original angle.

Other features including zoom and A-B prevent the changing of viewing angles.

Repeat Playback

Press REPEAT to repeat a track/scene

Pressing REPEAT once will repeat that track/scene only.

To repeat a chapter/title

Pressing REPEAT twice selects between TITLE and CHAPTER repeat modes.

To cancel REPEAT mode

Press the PLAY button, or cycle through the REPEAT options until REPEAT OFF is initiated.

Programmed Playback

Press PROGRAM in stop mode.

You can select up to 99 tracks to program. The program is maintained until the STOP button is pressed twice, the disc is removed or the unit is turned off.

To program tracks

Use the direction keys or number buttons to select a track. Once selected, press PROGRAM to enter it into the program. Repeat this procedure till you are complete with your program.

To start playback of a program

Press PLAY immediately following the above.

To cancel a program

You can cancel a program by pressing the STOP button twice, removing the disc is removed or turning off the unit.

Note: This function does not work unless you turn PBC off.

MP3 FUNCTIONS AND OPERATIONS

The DVX-580G can play back MP3 files recorded to CD-ROM, CD-R or CD-RW discs.

Notes on MP3 discs

An MP3 file stores audio data that has been compressed using the MPEG1 encoding scheme. Although PC terminology regarding MP3s and storage is, "files" and "folders," in this manual we refer to them as "tracks and albums."

Notes on playing MP3s

- An MP3 track must be recorded on a disc in the format compliant with ISO9660. Track order may differ from MP3 player to MP3 player.
- The maximum allowable number of tracks and/or albums located on a disc is 900, including the root albums (directory).
- The maximum allowable depth of a nested folder is 127, including files.
- If a disc contains both audio as well as MP3 tracks, it will not play in the DVX-580G.
- Multi-session discs are limited to a total of 20 sessions.
- MP3 playback is optimal with MP3s encoded with a sampling rate of 44.1 kHz and a fixed bit rate of 128 kbps.
- The unit may not play MP3 tracks recorded using a packet writing utility.
- The unit can only play back MP3 tracks having a file extension of ".mp3".
- It may take 30 seconds or more before the unit can start playback of MP3's. This time depends on the number of recorded tracks and the complexity of the album tree.
- If you play a non-MP3 track that has the ".mp3" file extension, the unit will skip to the next valid track automatically.
- Digital recordings with this unit cannot be done while playing back MP3 discs.

Notes on display indications during playback

- Up to 8 characters are displayed for the name of an album or track.
- Characters other than uppercase letters ("A" to "Z"), numerals ("0" to "9") and underscore ("_") may not be displayed, or may be displayed in different characters.
- The elapsed playing time may not be displayed correctly for MP3 tracks.
- Depending on the condition of the recording equipment or the CD-R/RW disc itself, a false album or track which cannot be played on the unit may be displayed on a TV screen.

Notes on creating MP3 discs

- When converting audio data to MP3, create MP3 files with a sampling frequency of 44.1 kHz and a fixed bit rate of 128 kbps.
- When creating MP3 discs, do not store more than 900 albums and/or tracks in a disc.
- To play tracks in the order they were recorded, ensure your encoding software is set up to auto arrange by name, or use only one album (if they are already alphabetized) or place a three digit number in front of each track to set an order manually.

Recommended = 001-Song.mp3, 002-Song.mp3, 003-Song.mp3...

Not Recommended = 1-Song.mp3, 5-Song.mp3, 10-Song.mp3...

MP3 Glossary

File Extension - A 3-character string added to a file name under the Windows or DOS environment is called a "file extension". A file extension is used mainly to identify types of files. The file extension for MP3 files is ".mp3".

ISO 9660 - ISO stands for the "International Organization for Standardization". ISO 9660 determines the file structure for CD-ROMs. This unit can play MP3 files recorded in the format compliant with ISO 9660.

Nesting of folders (albums) - To organize all your data files stored in a PC, you can store related files in a folder. A folder can contain other folders as well as files. For example, FOLDER A can contain FOLDER B (as well as files) and FOLDER B can contain FOLDER C (as well as other files).

Session - A session is one uninterrupted section of written data on a disc. A multi-session disc is a disc that has more than two sessions.

MP3 play mode

Load an MP3 disc.

The disc will automatically load and display the MP3 window. It may take up to 20 seconds for an MP3 disc to be read depending on the complexity of the file structure.

Enabling Smart Navigation.

Smart Navigation enables you to select one of 10 available MP3 playback modes.

If Smart Navigation is disabled, MP3 discs will autoplay with no menu options when inserted. You should still be able to forward or reverse tracks like a standard CD. To enable Smart Navigation see the PREFERENCES section.

MP3 FUNCTIONS AND OPERATIONS

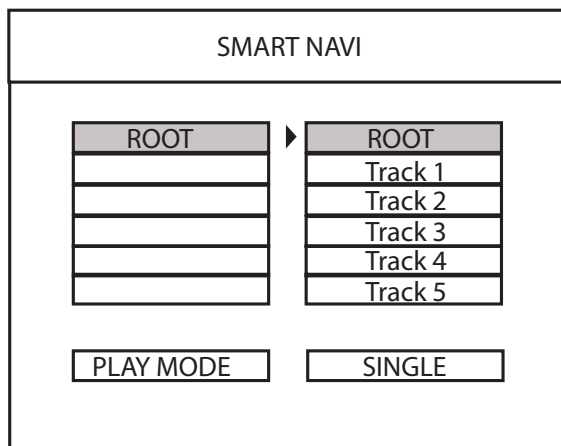

Selecting an MP3 PLAY MODE:

In order to see this menu automatically when you load an MP3 disc, SETUP MP3 under PREFERENCES must have WITH MENU selected. There are 10 available MP3 play modes to choose from. Use the direction keys to locate PLAY MODE field at bottom of SMART NAVI menu and up or down keys to select any of the following:

1. SINGLE mode

Plays files in a folder sequentially. Use the direction keys to move back to the track you want to play and press ENTER. Skipping tracks is not available in Single Mode.

2. REP-ONE mode

Repeats a single file. Use the direction key to move to the track you want to play and press ENTER. Track will repeat until operation is stopped.

3. FOLDER mode

Plays all files within a selected folder. Use the direction keys to select folder and press ENTER. Skipping tracks is not available in Folder Mode.

4. FOLDER REPEAT mode

Repeats all files within a selected folder until operation is stopped.

5. DISC SCAN mode

Plays the first 10 seconds of all files on the disc. Use the direction keys to select the MP3 file you want to start playback with. Press STOP to cancel DISC SCAN MODE.

6. DISC mode

Plays all files on the disc sequentially. Playback will stop after all files have been played once.

7. DISC REPEAT mode

Repeats all files on the disc infinitely until operation is stopped.

8. RANDOM mode

Plays all files on a disc in a random order.

9. SHUFFLE ON mode

Plays files from a selected folder in a random order. Use the direction keys to select folder. Playback is limited to one folder and will stop after all files have been played once.

10. PROGRAM mode

Plays user-programmed playlists from files in a selected folder. Use direction keys to find the files to program. Press ENTER after each file you want to add to program. Repeat process until program is complete. Press the STOP button to end file program selection. Press ENTER to begin playback. Program mode is limited to 20 files and will auto-stop after the program is complete.

DivX operations

In order to turn CDGs into DivX discs, you need to download three programs: 1) DivX Codec, a compressor/decompressor to compress converted files and compile DivX discs,
2) a CDG Ripper which will allow you to copy or "rip" CDGs to your PC as a CDG Bin file and 3) Power CDG to AVI Converter to convert these CDG Bin files to DivX format (AVI files).

Requirements

PC with internet connection

Hardware: CDG compatible CD or DVD drives; Yamaha, Liteon, Sony HP and Plextor are known for CDG compatible drives.

Software: DivX Codec, CDG Ripper and Power CDG to AVI Converter

You can download

1. DivX Codec at: <http://www.divx.com>. This program is free.
2. CDG Ripper at: <http://www.tricerasoft.com/cgi-bin/download.asp?prg=CDD1>
3. Power CDG to AVI Converter at: <http://www.powerkaraoke.net/download/powercdg2avi.exe>

Follow each website's directions for download of these programs.

We have provided basic instructions for ripping CDGs and Converting these files to AVI files. Refer to the help menu for each program for further assistance.*

To Rip CDGs

1. Insert CDG into your CD or DVD drive on your PC.
2. Create a new folder on your hard drive and name it "CDG," for example.
3. At the bottom of the screen select OUTPUT PATH to your new folder as the destination.
4. Select all tracks and click on CONVERT.
5. Select EXTRACT TO BIN
6. Set default in QUICK OPTION to STEREO. Do not click on VOCAL REMOVE.

Each song should take approximately one minute for the ripping process to finalize, depending on your system.

You will see file names Track01.BIN, Track02.BIN, etc. when disc has been ripped.

To convert from CDG BIN files to AVI files

1. Create a new folder in your hard drive and name it "CDGDIVX," for example.
2. Open the program and select BATCH for batch encoding.
3. Click ADD and select the BIN files you previously created with the CDG ripper from the appropriate folder. Click OPEN.
4. Click on VIDEO COMPRESSION and select DivX Pro 5.1.1 Codec and click OK
5. Click on AUDIO COMPRESSION and select MPEG LAYER-3. Under ATTRIBUTE select 48KBIT 22050 STEREO and click OK.
6. Click OUTPUT DIRECTLY. Click BROWSE and select your CDGDIVX folder.
7. Click CONVERT

Each file should take approximately one minute to encode, depending on your system. The final files should each have an AVI extension and each file should be at least 10MB or less.

* DivX Networks, Inc, Tricerasoft, Power Karaoke and the Power CDG to AVI Converter are not affiliated with VocoPro. VocoPro makes no claims about their products and assumes no responsibility for the effectiveness of them.

SPECIFICATIONS

Supported Disc Formats: DVD, SVCD, HDCD, VCD 2.0-3.0, MP3, Audio CD

Supported Discs: 12 cm single sided, single layer

12 cm single sided, double layer

12 cm double sided, single layer

12 cm double sided, double layer

8 cm single sided, single layer

8 cm single sided, double layer

8 cm double sided, single layer

8 cm double sided, double layer

Video System: NTSC (525/60, 625/50) PAL (625/50, 525/60)

Video Output Level: 1.0 V rms (75 Ω Unbalanced)

S-Video Output: Y: 1.0 V rms (75 Ω Unbalanced)

C: 0.286 Vp-p (75 Ω) NTSC

0.3 Vp-p (75 Ω) PAL

1 Mini Din 4-pin

YUV Video Output: Y: 1.0 V rms (75 ohms Unbalanced)

Cr: 0.7 Vp-p (75 Ω Unbalanced)

Cb: 0.7 Vp-p (75 Ω Unbalanced)

3 RCA Jacks

Audio System: MPEG 1-2

Linear PCM Audio

Dolby Digital (AC-3)

DTS

Digital Output: 0.5 V rms (75 Ω)

Optical Output

Coaxial Output

Analog Output: 2.0 V rms (1kHz, 0dB, 330 Ω)

2 RCA Jacks

DVD Linear Audio Characteristics

Frequency Response: 4Hz-22kHz (Fs=48kHz)

4Hz-44kHz (Fs=96kHz)

S/N Ratio: 105dB (Fs=48kHz, 24-bit PCM)

Dynamic Range: 105dB (Fs=48kHz, 24-bit PCM)

Maximum Audio Distortion: 0.05% (Fs=48kHz, 24-bit PCM)

Audio Characteristics

Frequency Response: 20Hz-20kHz (+/- 1dB)

S/N Ratio: > 80dB (EIAJ)

Dynamic Range: 90dB (EIAJ)

Power Supply: 110-240V~50/60Hz

Power Consumption: 25 W



[www .vocopro.com](http://www.vocopro.com)

VocoPro

ULTIMATE CHOICE OF KARAOKE ENTERTAINMENT